



CLICK SYSTEM



CLICK SYSTEM

LINEAR SYSTEMS

onoklighting.com/es/click-system

Mostrar cada objeto, cada escena, cada momento de una determinada manera, así es como transmitimos sensaciones, como transmitimos emociones. Sabemos que las emociones son infinitas, en ONOK hemos creado nuestra gama de iluminación más versátil hasta la fecha. El CLICK System. Una línea que combina diferentes sistemas de focos y perfiles que permiten hasta 1912 combinaciones con las que conseguir exactamente la iluminación que estás buscando.

To show every object, every scene, every moment in a certain way, this is how we express sensations, how we transmit emotions. We know that the emotions are endless, at ONOK we have created our most versatile lighting. The CLICK System. A line that combines different luminaires and profiles that allow until 1912 different combinations to get exactly the lighting effect that you are looking for.





Profile R
P.12



C. Focus 25
P.24

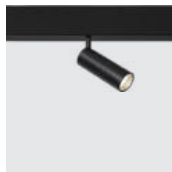

C. Focus 40
P.25

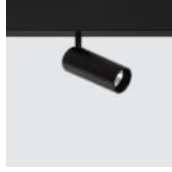

C. Focus 55
P.26



C. Tube
P.29



C. Dot 5
P.31

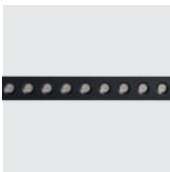

C. Dot 10
P.31

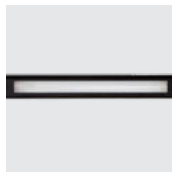

C. Linear 5
P.35

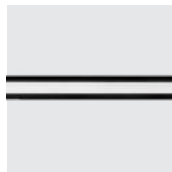

C. Linear 10
P.35

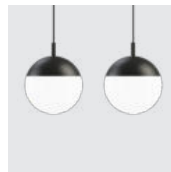

C. Balo Pendat
P.39

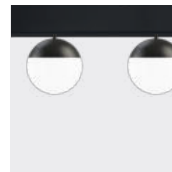

C. Balo Up
P.39



Mont
P.43



Wallwasher
P.45



Kit Bluetooth
P.50

CLICK SYSTEM

LINEAR SYSTEMS

PERFILES / PROFILES

El sistema cuenta con un perfil, que por medio de diferentes accesorios configura la instalación. Se encuentra disponible en 1, 1.5, 2 y 3 metros.

The system has a profile, you can configure this system with different accessories. It is available in 1, 1.5, 2 and 3 meters

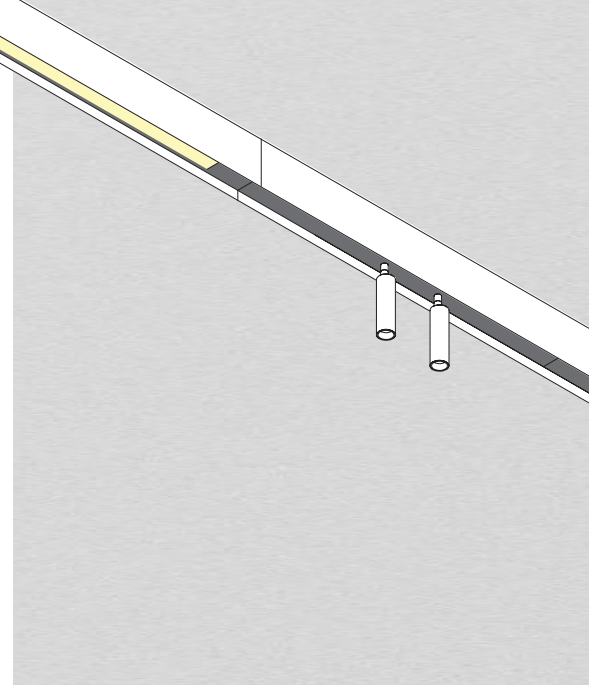

Frameless version

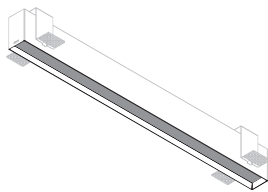

La versión frameless, se caracteriza por estar rehundido en el techo, lo que te permitirá conseguir líneas más limpias, donde el protagonismo lo adquiere tu espacio.

In the frameless version the main feature is being recessed in the ceiling, this allows you to get cleaner lines, where the space is the main character.

Surface Version

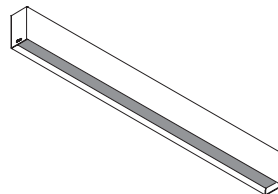

La versión de superficie se caracteriza por una fácil instalación, es de mucha utilidad cuando tienes techos de hormigón o estructuras que no te permiten empotrar luminarias.

The Surface version main feature a simple installation, it is very useful when you have concrete ceilings or structures that doesn't allow you to embed luminaires.

Pendant Version

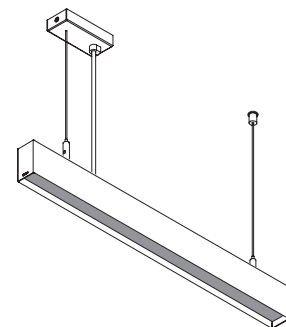

La versión colgante te ayudara en espacios con alturas considerables, pero por otra parte en lo estético da ese toque de acompañamiento y decoración en esos espacios que quieres realzar.

The pendant version will help you in spaces with considerable heights, this luminaire looks really nice, it gives to every place the best decoration.

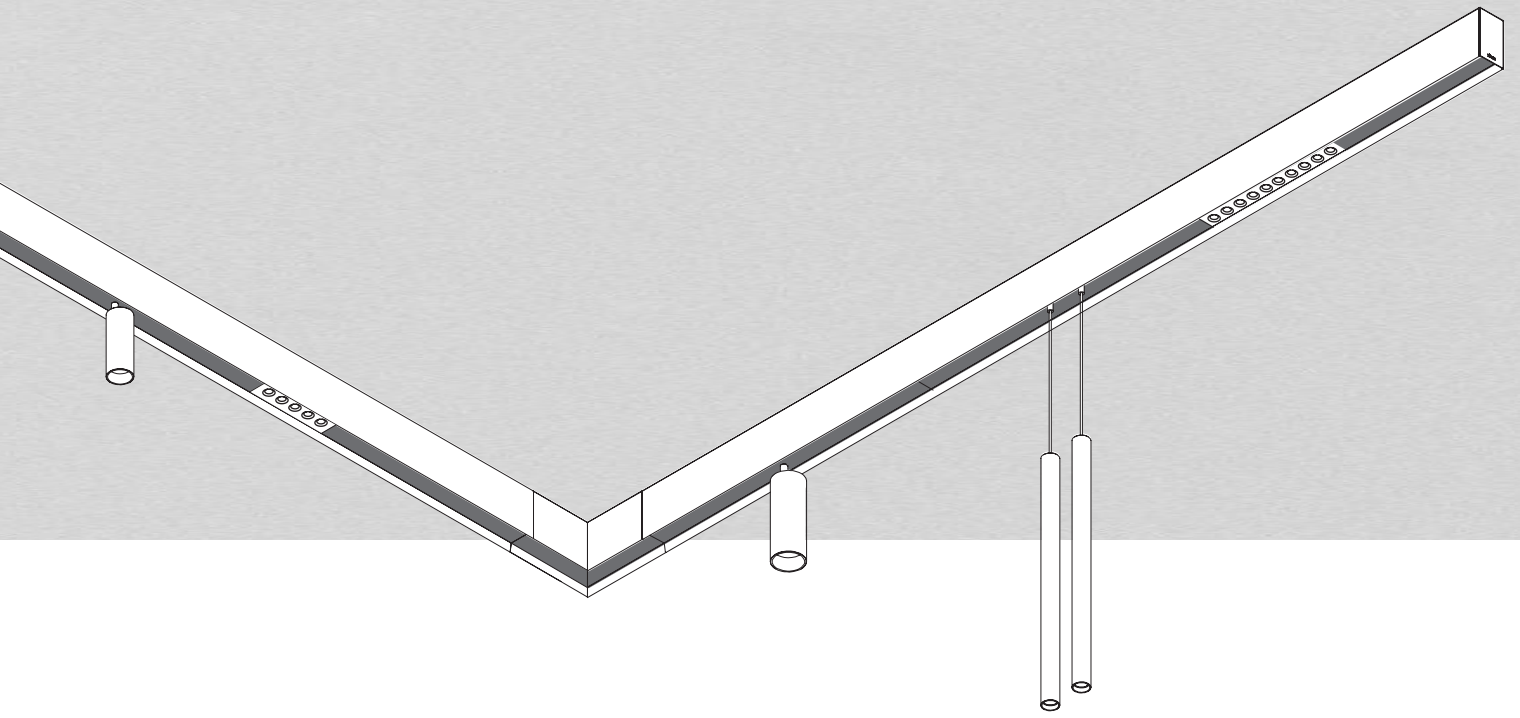

Acabados/Finishes

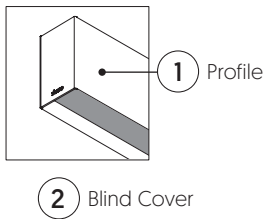

Blanco-Blanco / White-white

1 2

Negro-Negro / Black-Black

1 2

Blanco-Negro / White-Black

1 2

Continuos / Continuous

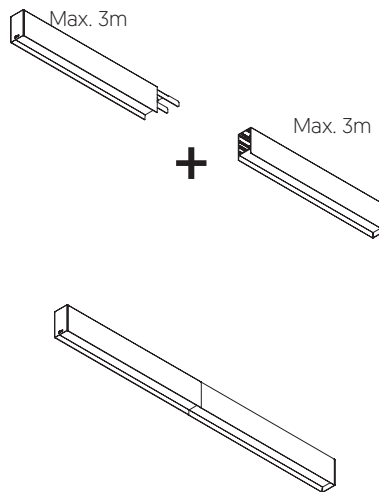

Esquina / Corner

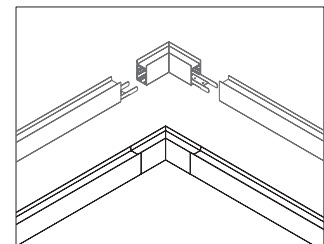

14cm 14cm

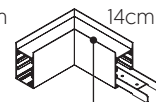

Solo tapa ciega /
Only blind cover



PROFILE & MODULES

LINEAR SYSTEMS

COMING SOON



PROFILE

Electrified profile

		PROFILE R	PROFILE RF
DIMENSIONS		7.5 x 4.3 cm	8.8 x 7.5 cm
INSTALLATION	Surface	•	
	Pendant	•	
	Frameless		•
FINISH	Black	•	•
	White	•	
	White& Black	•	
ACCESORIES	Corner Ceiling	•	•
	Corner Ceiling -Wall	•	•

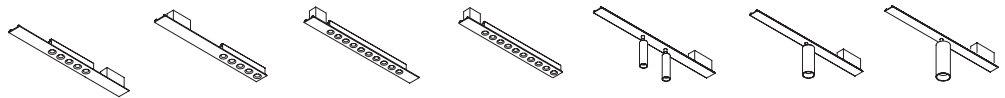

MODULE

*driver included

		DOT 5C	DOT 5D	DOT 10C	DOT 10D	FOCUS 25	FOCUS 40	FOCUS 55
DIMENSIONS		50cm	50cm	50cm	50cm	50cm	50cm	50cm
TECHNICAL DATA		1079lm	1079lm	2158lm	2158lm	2 x 500lm	673lm	1345lm
	W	10W	20W	20W	20W	12W	8.4W	12.2W
	CRI	>90	>90	>90	>90	>90	>90	>95
	T. Color	3K - 4K	3K - 4K	3K - 4K	3K - 4K	3K - 4K	3K - 4K	2.7K - 3K - 4K
	B.Angle	19° - 34°	19° - 34°	19° - 34°	19° - 34°	25°	25°	16° - 25° - 40°
CONTROL	On-Off	•	•	•	•	•	•	•
	Dali	•	•	•	•	•	•	•
	Bluetooth	•	•	•	•	•	•	•
	Casambi	•	•	•	•	•	•	•
FINISH	Black	•	•	•	•	•	•	•
	White	•	•	•	•	•	•	•
	Polished					•	•	•
	Copper					•	•	•
OPTICAL	Reflector							•
	Lens	•	•	•	•	•	•	

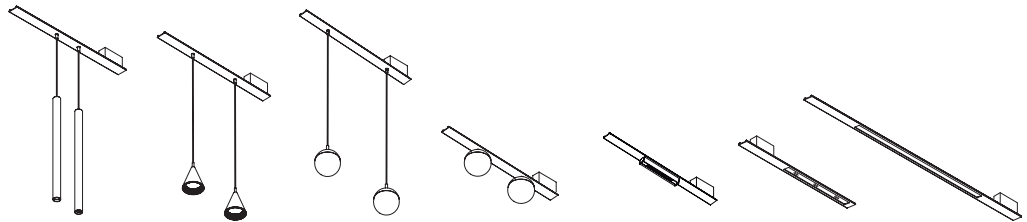

MODULE

*driver included

		TUBE 25	MONT	BALO PEND.	BALO UP	WALLWASHER	LINEAR 05	LINEAR 10
DIMENSIONS		50cm - Ø25	50cm - Ø74	50cm - Ø90	50cm - Ø90	50cm	50cm	100cm
TECHNICAL DATA		2 x 500lm	2 x 755lm	2 x 505lm	2 x 505lm	1100lm	1200lm	2500lm
	W	12W	10W	8.2W	8.2W	10W	5.6W	16W
	CRI	>90	>80	>80	>80	>90	>80	>80
	T. Color	3K - 4K	3K	2.7K - 3K	2.7K - 3K	3K	3K - 4K	3K - 4K
	B.Angle	25°	35°	120°	120°	Wallwasher	120°	120°
CONTROL	On-Off	•	•	•	•	•	•	•
	Dali	•	•	•	•	•	•	•
	Bluetooth	•	•	•	•	•	•	•
	Casambi	•	•	•	•	•	•	•
FINISH	Black	•	•	•	•	•	•	•
	White	•					•	•
	Polished	•						
	Copper	•						
OPTICAL	Reflector		•				•	•
	Lens	•				•		









**Dot
P.67**

El primer módulo desarrollado para el sistema Click, con un magnífico confort visual que enamora todas las miradas.

The first module developed for the Click System, with a magnificent visual comfort that captivates every eye.

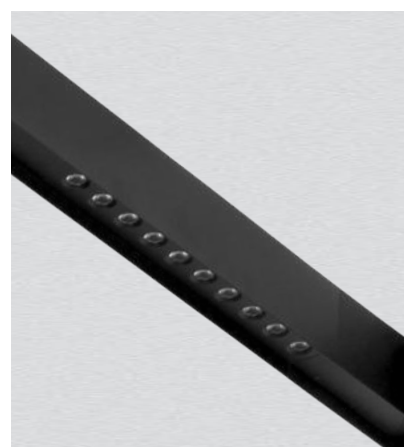

**Focus 25
P.60**

El proyector más pequeño diseñado en la historia de Onok y por supuesto sin dejar de lado la eficiencia.

The smallest spotlight designed in the history of Onok with the same efficiency as always



**Focus 55
P.62**

El mayor de los proyectores en el sistema es el encargado de iluminar esos espacios que requieren más luz.

The biggest spotlight in the Click System, it is the responsible to illuminate those spaces that requires more light.



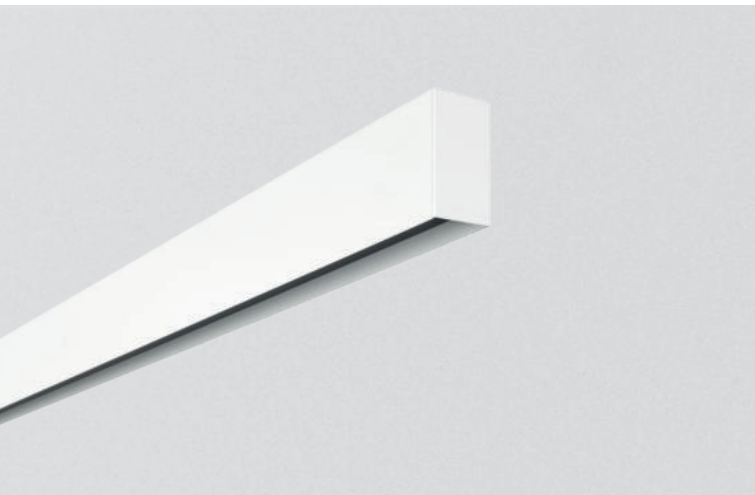

CLICK PROFILE R

LINER SYSTEMS



Perfil rehundido de extrusión de aluminio, en acabado texturizado en blanco y negro, version para no-dim y dimmable. Instalación colgante, frameless y superficie.

Aluminum extruded recessed profile, in black and white textured finish, version for non-dim and dimmable. Pendant, frameless and surface version.

TEC.DRAWINGS

PENDANT VERSION

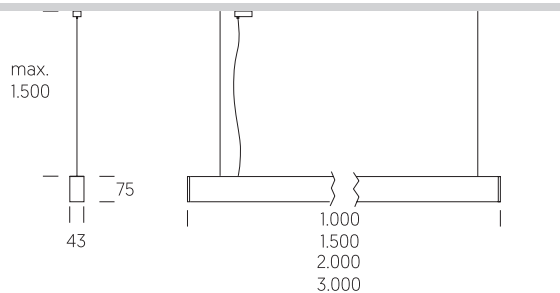

SURFACE VERSION

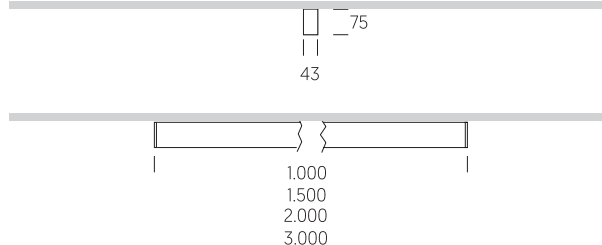

FRAMELESS VERSION

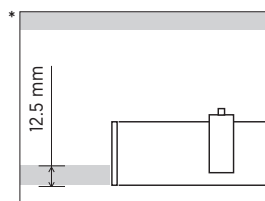
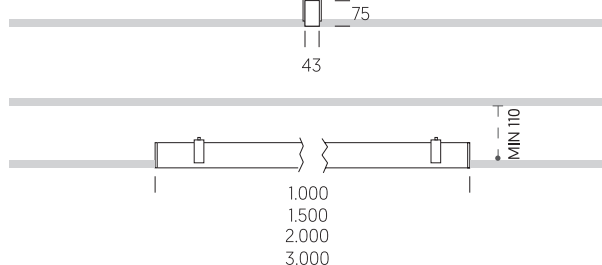

Para techos de 12.5 mm/ Ceiling thickness 12.5 mm

INSTALLATION PHOTOS



Colgante-Pendant



Surface-Superficie

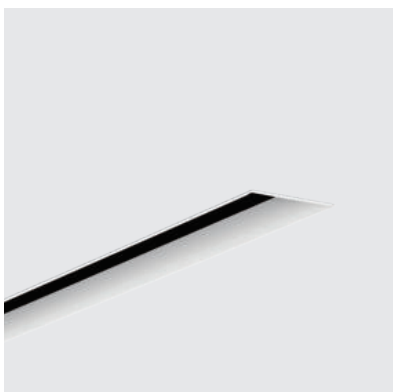

Frameless

LED		230V	IP20
-----	--	------	------

1.000mm	KPRX	X	10	•	X	X	X	•	•
1.500mm	KPRX	X	15	•	X	X	X	•	•
2.000mm	KPRX	X	20	•	X	X	X	•	•
2.500mm	KPRX	X	25	•	X	X	X	•	•
3.000mm	KPRX	X	30	•	X	X	X	•	•

CUSTOMIZE OPTIONS

LED CONTROL

	N	No Dimmable	KPRX	X	•	•	N	X	X	•	•
	D	Dimmable Dali	KPRX	X	•	•	D	X	X	•	•
	K	Casambi	KPRX	X	•	•	K	X	X	•	•
	B	Bluetooth	KPRX	X	•	•	B	X	X	•	•

COLOURS

	WS	Satin White	KPRX	X	•	•	N	X	X	•	WS
	BS	Satin Black	KPRX	X	•	•	N	X	X	•	BS

COMPLEMENTS CODES

PENDANT VERSION

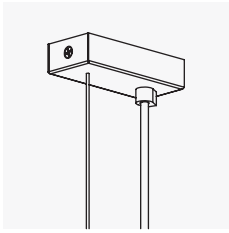

Electrical Susp. NO-DIM
White CCLICK20BLN00
Black CCLICK20NEN00

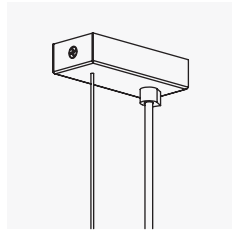

Electrical Susp. DIM
White CCLICK20BL000
Black CCLICK20NE000

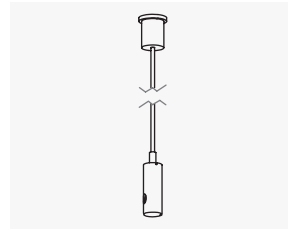

Kit Suspension
White CCLICK19BL000
Black CCLICK19NE000

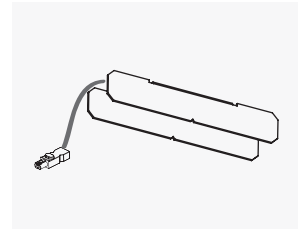

Kit Electrical Union
No-Dim CCLICK17RW000
Dim CCLICK18RW000

INDIVIDUAL VERSION

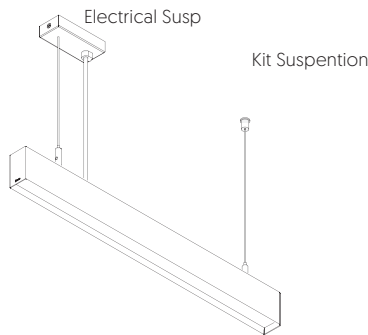

CONTINUOUS VERSION

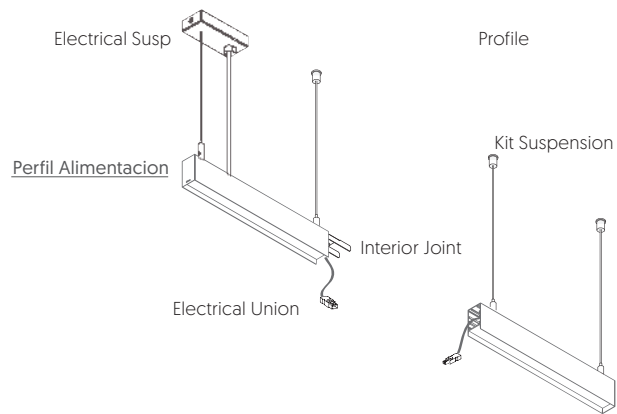

IMPORTANTE: Una alimentación para máximo 35 Luminarias.
ATTENTION: Maximum 35 Luminaires per one Electrical Suspension.

GUÍA COMPLEMENTOS/ COMPLEMENTS GUIDE

Perfil con alimentación / Profile with Electrical Suspension

Ref.	Length	Elec. Susp.	Kit Susp.	X	Y
Profile R10	1000 mm	1	1	900	50
Profile R15	1500 mm	1	1	1400	50
Profile R20	2000 mm	1	1	1900	50
Profile R25	2500 mm	1	1	2400V	50
Profile R30	3000 mm	1	1	2900	50

Especial para individuales o iniciales para continuos / Special for individuals or initials for continuous

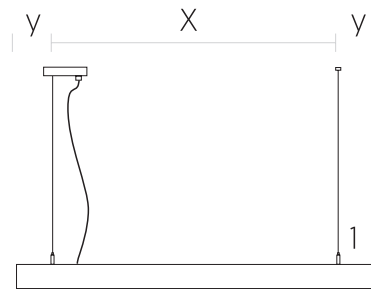

Perfil sin alimentación / Profile with out Electrical Suspension

Ref.	Length	Kit Susp.	Elec. Union	X	Y
Profile R10	1000 mm	2	1	900	50
Profile R15	1500 mm	2	1	1400	50
Profile R20	2000 mm	2	1	1900	50
Profile R25	2500 mm	2	1	2400	50
Profile R30	3000 mm	2	1	2900	50

Especial para líneas continuas / Special for continuous lines.

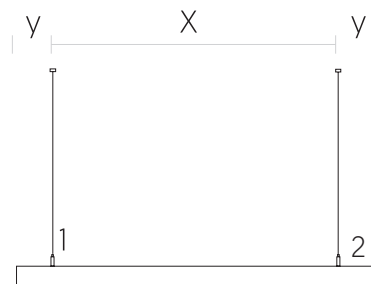

COMPLEMENTS CODES

FRAMELESS VERSION

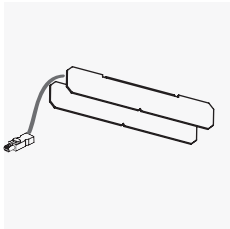

Interior Joint

No-Dim CCLICK17RW000
Dim CCLICK18RW000

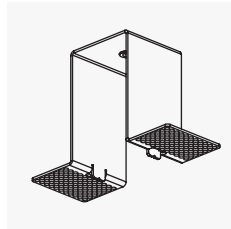

Ceiling Bracket Line R

CCLICK15RW000

INDIVIDUAL VERSION

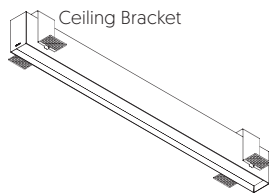

Ceiling Bracket

CONTINUOUS VERSION

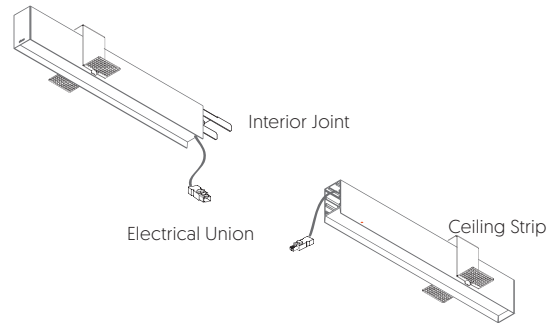

Interior Joint

Electrical Union

Ceiling Strip

GUÍA COMPLEMENTOS/ COMPLEMENTS GUIDE

Ref.	Lenght		Ceiling strip
Profile R10	1000 mm	1010x47	2
Profile R10	1500 mm	1510x47	2
Profile R10	2000 mm	2010x47	3
Profile R10	2500 mm	2510x47	4
Profile R10	3000 mm	3010x47	4



IMPORTANTE: Una alimentación para máximo 35 Luminarias.
ATTENTION: Maximum 35 Luminaires per one Electrical Suspension.

COMPLEMENTS CODES

SURFACE VERSION

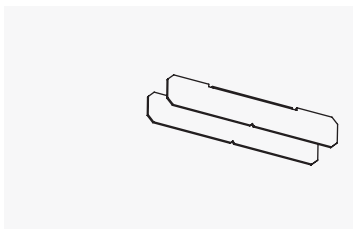

Interior Joint

INDIVIDUAL VERSION

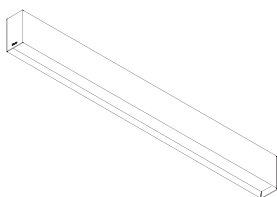

CONTINUOUS VERSION

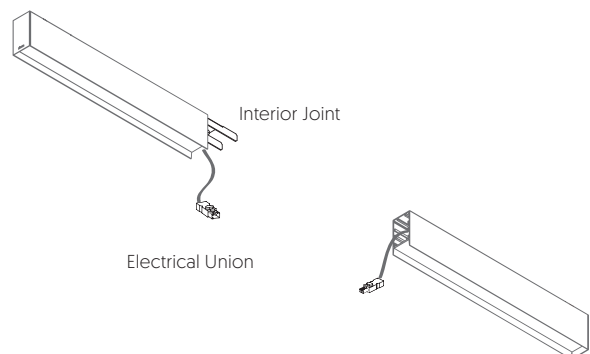

Interior Joint

Electrical Union



CLICK CORNER LINEAR SYSTEMS

Este sistema cuenta con dos tipos de esquina, una primera a techo y una segunda que va techo a pared.

We offer two types of corner, one onli at roof and another that goes from ceiling to wall.

ACCESSORIES

Disponible para las tres versiones colgante, superficie y frameless.
Available in pendant, surface and frameless version.

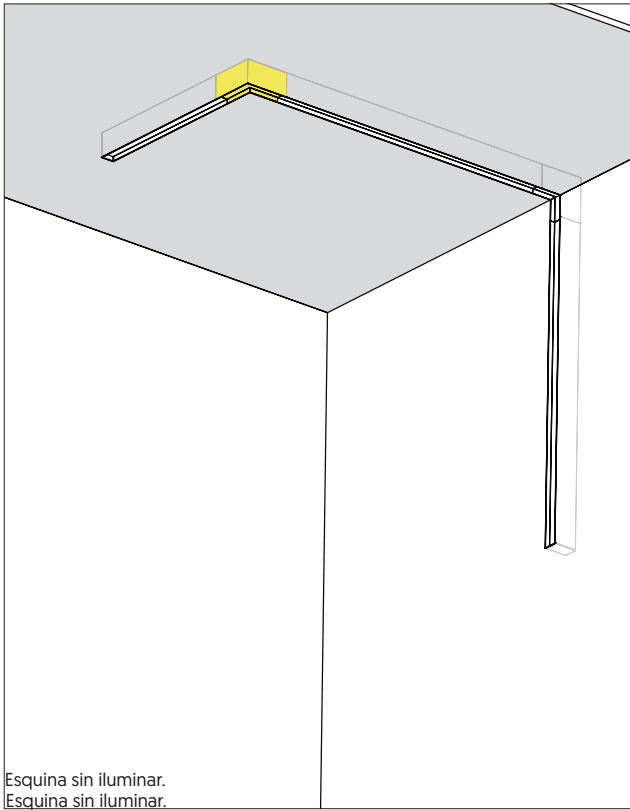

CLICK CORNER CEILING

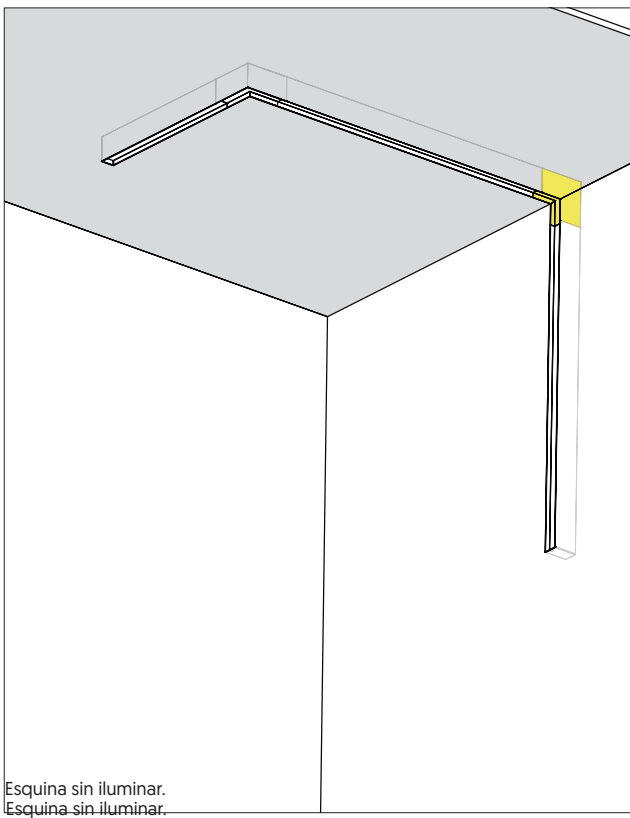
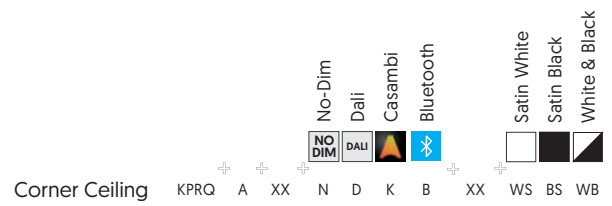
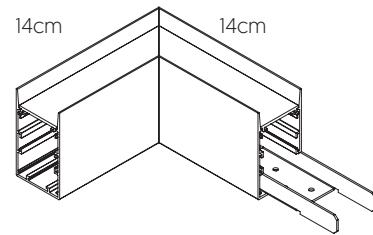

CLICK CORNER CEILING-WALL

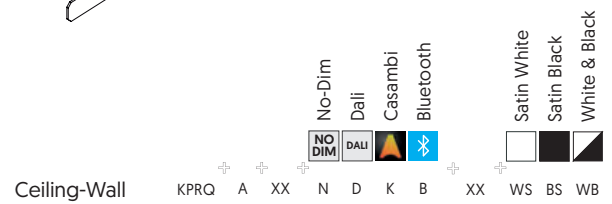
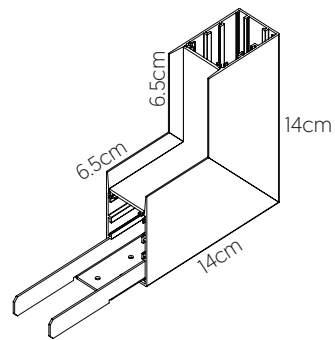
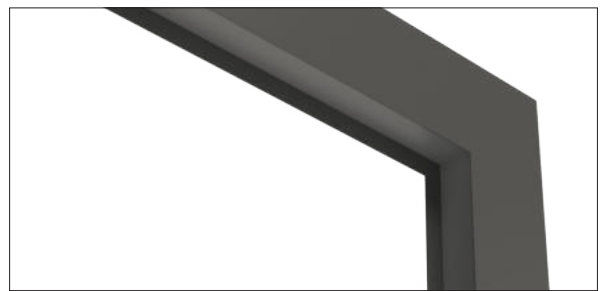

Click Focus

Focus 25-Focus 40-Focus 55



Luz de acento orientable / Adjustable accent light

La familia Focus se compone de tres proyectores en diferentes medidas y potencia, se caracteriza por ser una luz de acento orientable, ideal para los espacios que se quieren realzar

Focus family is composed by three spotlights in different measures and power, it's characterized by being an adjustable light, the best for spaces like expositions.



Luz de acento fija / Fixed accent light

Tube es una luz de acento fijo, que remarca con más acento objetos que están a media altura, además de delimitar y remarcar límites en el espacio.

Tube luminaire it's a fixed light which emphasizes with more accent objects that are at medium height.

Click Dot
Dot 5 - Dot 10



Luz de acento lineal / Linear accent light

La familia Dot se distingue por una luz de acento lineal, que es adecuada para enaltecer esos espacios longitudinales.

The Dot family is distinguished by a linear accent light, which is suitable to enhance these longitudinal spaces.

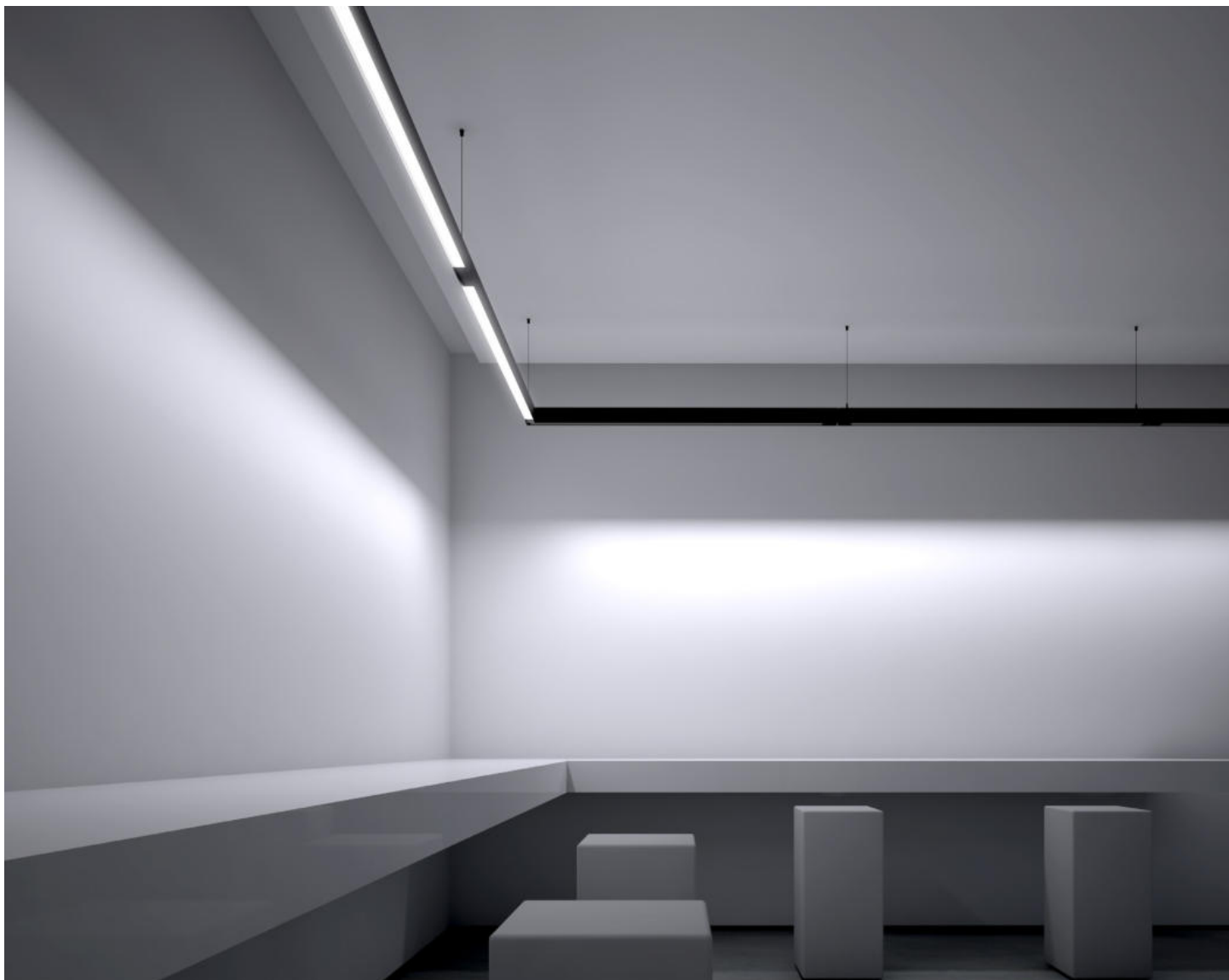

Luz de ambiente / General light

El linear es una luminaria ideal para dar una luz ambiente a esos espacios que requieren de iluminación general.

The linear luminaire is ideal for those spaces that require general lighting.

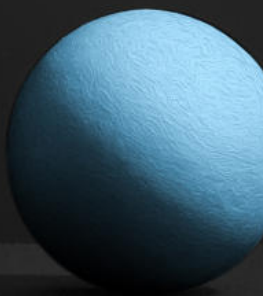



FOCUS

LINEAR SYSTEMS

Familia de Proyectores compacta adaptado al Click System. Con un CRI > 90, podemos dirigir la luz hacia lo que importa. Ideal para crear varias escenas en un mismo espacio.

Spotlight family adapted to the Click System with CRI > 90, you can point the light wherever you want. Ideal to create different scenes in one place.



CLICK FOCUS 25

LINEAR SYSTEMS



	W	mA	TEMP	LUM	CRI
FOCUS 25	12,6	500	2.700K	2x521	>90
			3.000K	2x559	
			4.000K	2x597	

LED
230V
IP20
90°
350°

≈ 12W > 2x500lm **KFC2 A 25 • • 2 A ••**

BASIC OPTIONS

NO DIM	N	No Dimmable							
3K	3								
	2	25°							
	A	Ice Difusser							
	WS	Satin White	KFC2	A	25	N	3	2	A WS
	BS	Satin Black	KFC2	A	25	N	3	2	A BS

TEC.DRAWINGS

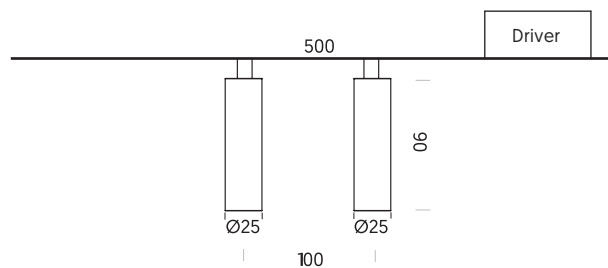

CUSTOMIZE OPTIONS

LED CONTROL

	D	Dimmable Dali	KFC2	A	25	D	•	2	A ••
	K	Casambi	KFC2	A	25	K	•	2	A ••
	D	Bluetooth	KFC2	A	25	D	•	2	A ••

LED COLOR TEMPERATURE

2.7K	2	2700K	KFC2	A	25	•	2	2	A ••
4K	4	4000K	KFC2	A	25	•	4	2	A ••

COLOURS

	PB	Polished & Black	KFC2	A	25	•	•	2	A PB
	CB	Copper & Black	KFC2	A	25	•	•	2	A CB

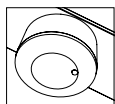

Para versión Bluetooth añadir Kit B.
For Version Bluetooth please add the Kit B.

CLICK FOCUS 40

LINEAR SYSTEMS



	W	mA	TEMP	LUM	CRI
FOCUS 40	7.8	700	2.700K	694	>90
			3.000K	745	
			4.000K	796	

TEC.DRAWINGS

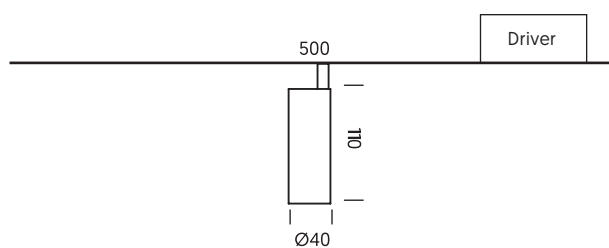

≈ 8W > 700lm **KFC4 A 40 . . 2 A ..**

BASIC OPTIONS

NO DIM	N	No Dimmable								
3K	3	3000K								
2	2	25°								
A	A	Ice Difusser								
WS	WS	Satin White	KFC4	A	40	N	3	2	A	WS
BS	BS	Satin Black	KFC4	A	40	N	3	2	A	BS

CUSTOMIZE OPTIONS

LED CONTROL

DALI	D	Dimmable Dali	KFC4	A	40	D	.	.	2	A	..
K	K	Casambi	KFC2	A	40	K	.	.	2	A	..
D	D	Bluetooth	KFC2	A	40	D	.	.	2	A	..

LED COLOR TEMPERATURE

2.7K	2	2700K	KFC4	A	v	.	.	2	2	A	..
4K	4	4000K	KFC4	A	40	.	.	4	2	A	..

COLOURS

PB	PB	Polished & Black	KFC4	A	40	.	.	.	2	A	PB
CB	CB	Copper & Black	KFC4	A	40	.	.	.	2	A	CB

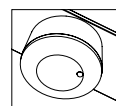

Para versión Bluetooth añadir Kit B.
For Version Bluetooth please add the Kit B.

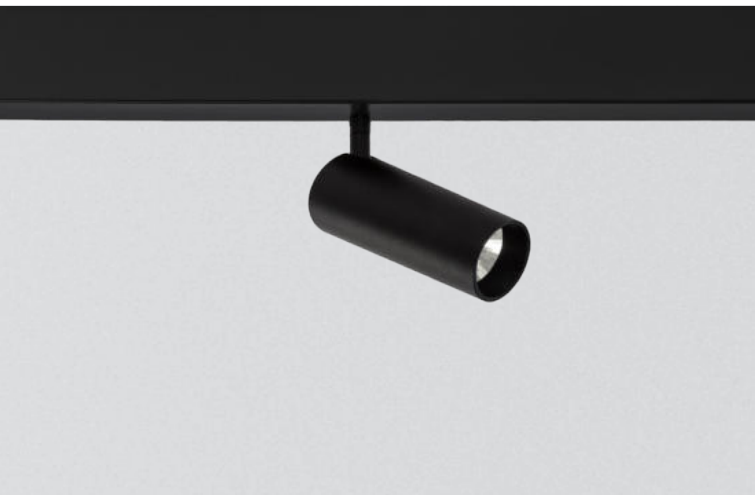

CLICK FOCUS 55

LINEAR SYSTEMS



	W	mA	TEMP	LUM	CRI
			2.700K	1.165	
FOCUS 55	12.2	350	3.000K	1.245	>95
			4.000K	1.380	

≈ 12W > 1.300lm **KFC5 A 55 . . 4 . .**

BASIC OPTIONS

	N	No Dimmable							
	3	3000K							
	2	25°							
	B	Clear Difusser							
	WS	Satin White	KFC5	A	55	N	3	2	B WS
	BS	Satin Black	KFC5	A	55	N	3	2	B BS

CUSTOMIZE OPTIONS

LED CONTROL										
	D	Dimmable Dali	KFC5	A	55	D
	K	Casambi	KFC5	A	55	K
	D	Bluetooth	KFC5	A	55	D
LED COLOR TEMPERATURE										
	2	2700K	KFC5	A	55	.	2	.	.	.
	4	4000K	KFC5	A	55	.	4	.	.	.
LED BEAM ANGLE										
	1	16°	KFC5	A	55	.	.	1	.	.
	4	40°	KFC5	A	55	.	.	4	.	.
LED COMPLEMENTS										
	P	Cross	KFC5	A	55	.	.	.	P	.
COLOURS										
	PB	Polished & Black	KFC5	A	55	PB
	CB	Copper & Black	KFC5	A	55	CB

TEC.DRAWINGS

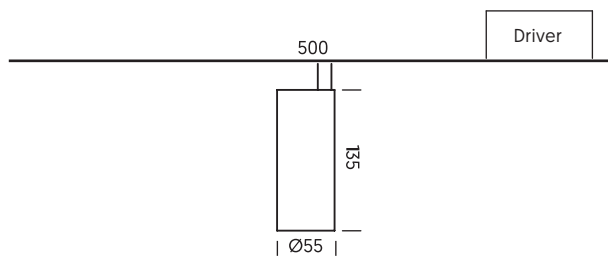

COMPLEMENTS

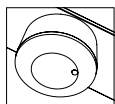
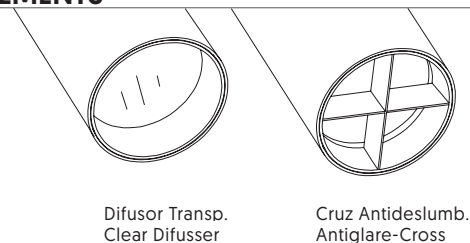

Para versión Bluetooth añadir Kit B.
 For Version Bluetooth please add the Kit B.

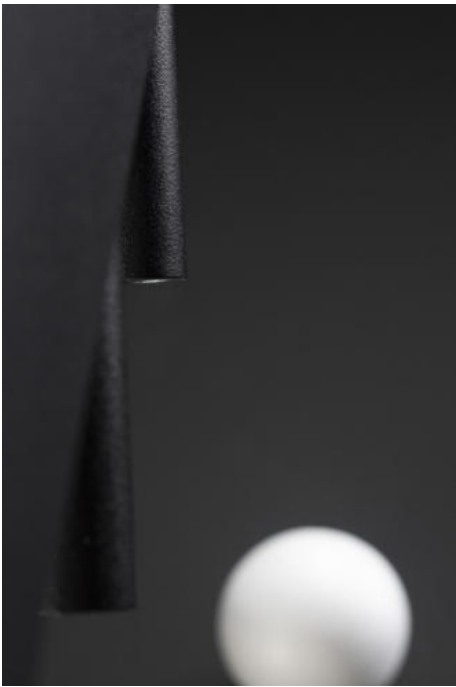

TUBE

LINEAR SYSTEMS

Fina y extremadamente elegante, esta luminaria de alto rendimiento nos permite iluminar esos pequeños detalles que dan valor a un espacio.

Además de cumplir funciones de iluminación, el Tube puede demarcar esos espacios a los cuales quieres darle la importancia que se merece.

Thin and extremely elegant, this high-performance luminaire allows us to illuminate those small details that give better value to a space.

This luminaire gives more importance to the place that you want to show, like tables, bar, desk etc.

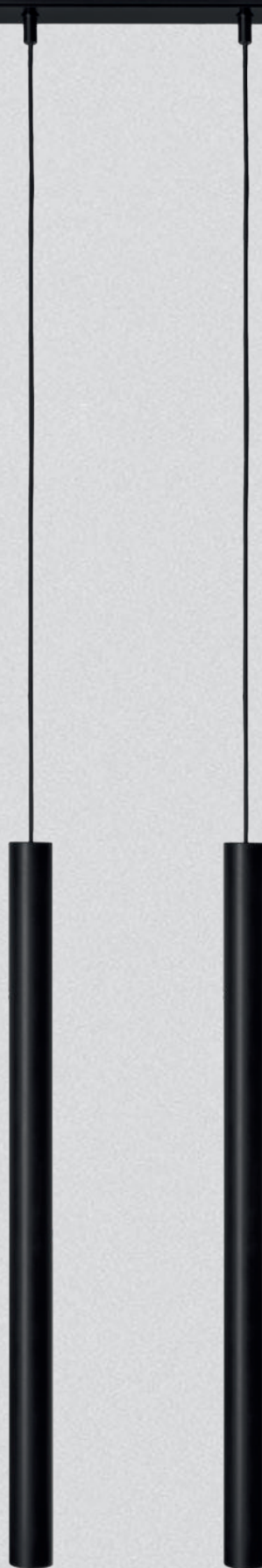

CLICK TUBE 25

LINEAR SYSTEMS



	W	mA	TEMP	LUM	CRI
TUBE 25	12,6	500	2.700K	2x521	>90
			3.000K	2x559	
			4.000K	2x597	

TEC.DRAWINGS

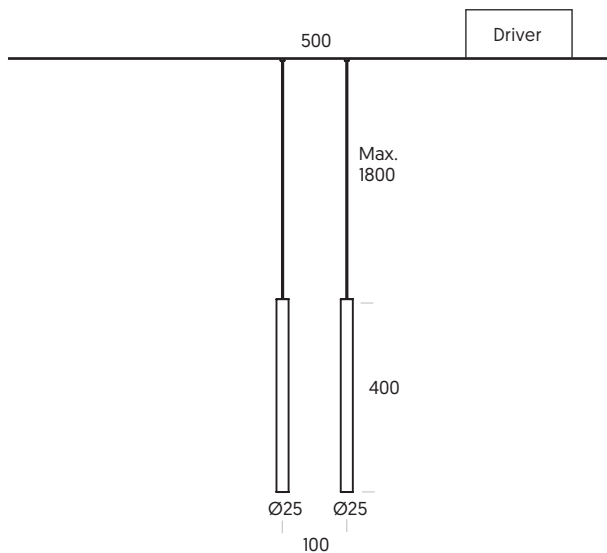

LED 230V IP20

≈ 6W > 500lm **KTB2 A 25 • • 2 A ••**

BASIC OPTIONS

N	No Dimmable	
3	3000K	
2	25°	
A	Ice Difusser	
WS	Satin White	KTB2 A 25 N 3 2 A WS
BS	Satin Black	KTB2 A 25 N 3 2 A BS

CUSTOMIZE OPTIONS

LED CONTROL		
D	Dimmable Dali	KTB2 A 25 D • 2 A ••
K	Casambi	KTB2 A 25 K • 2 A ••
D	Bluetooth	KTB2 A 25 D • 2 A ••
LED COLOR TEMPERATURE		
2	2700K	KTB2 A 25 • 2 2 A ••
4	4000K	KTB2 A 25 • 4 2 A ••
COLOURS		
PB	Polished & Black	KTB2 A 25 • • 2 A PB
CB	Copper & Black	KTB2 A 25 • • 2 A CB

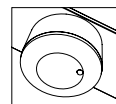

Para versión Bluetooth añadir Kit B.
For Version Bluetooth please add the Kit B.

DOT LINEAR SYSTEMS

Con un CRI >90, esta luminaria ofrece altos rendimientos con un elevado confort visual gracias a su lente especial anti-deslumbramiento, también cuenta con dos opciones de grados de apertura que puedan adaptarse a tus proyectos.

This luminaire with CRI >90 offers high performance with excellent visual comfort, thanks to the special anti-glare lens, it also has two possible beam angles that can be adapted to your projects.

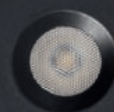

CLICK DOT

LINEAR SYSTEMS



	W	mA	TEMP	LUM	CRI
DOT 5	10	700	2.700K	1.000	>90
			3.000K	1.079	
			4.000K	1.155	
DOT 10	20	700	2.700K	2.058	>90
			3.000K	2.158	
			4.000K	2.310	

TEC.DRAWINGS

DOT 5

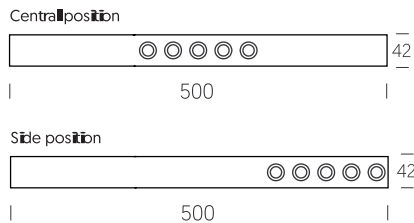

DOT 10

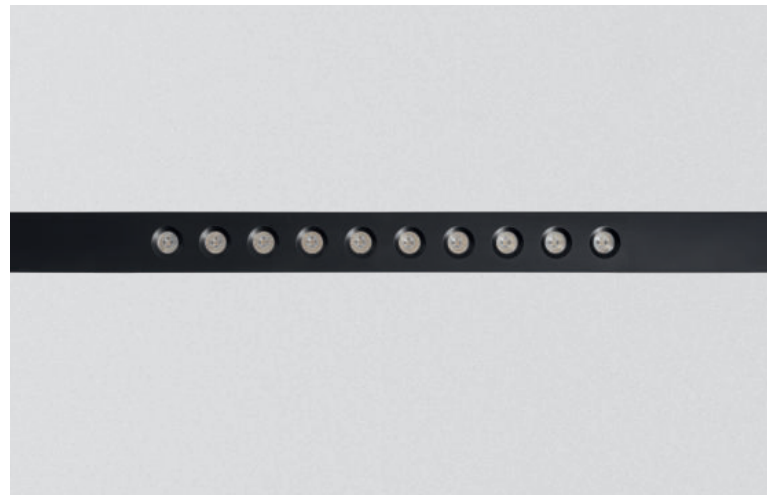
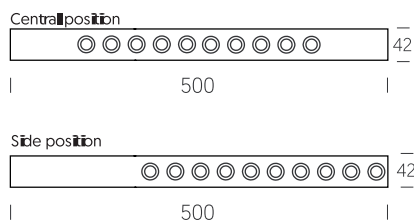

LED 230V IP20

5P ≈ 10W > 1.000lm **KDT5 A 05**
 10P ≈ 20W > 2.000lm **KDT1 A 10**

BASIC OPTIONS

N	No Dimmable						
3	3000K						
3	30°						
C	Central position						
WS	Satin White	KDT · A	05	N	3	3	C WS
		KDT · A	10	N	3	3	C WS
BS	Satin Black	KDT · A	05	N	3	3	C BS
		KDT · A	10	N	3	3	C BS

CUSTOMIZE OPTIONS

LED CONTROL							
D	Dimmable Dali	KDT · A	.	D
K	Casambi	KDT · A	.	K
D	Bluetooth	KDT · A	.	D
LED COLOR TEMPERATURE							
2	2700K	KDT · A	.	.	2	.	..
4	4000K	KDT · A	.	.	4	.	..
LED BEAM ANGLE							
1	19°	KDT · A	.	.	.	1	..
DOT POSITION							
D	Side position	KDT · A	D PB

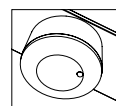

Para versión Bluetooth añadir Kit B.
 For Version Bluetooth please add the Kit B.





LINEAR

LINEAR SYSTEMS

Diseñado para dar esa luz que viene bien a todos los espacios, Linear es una luminaria con un ángulo de apertura de 120° en dos diferentes medidas, esto te permite decidir si quiere iluminar longitudes más cortas o más largas. Además el difusor microprismático es una buena solución para reducir el UGR.

Designed to give the light that looks nice in every space, this luminaire has a beam angle of 120° with two different dimensions, this allows you to illuminate longer or shorter lengths. In addition the microprismatic diffuser is a good solution to reduce the UGR.



CLICK LINEAR

LINEAR SYSTEMS



	W	mA	TEMP	LUM	CRI
LINEAR 05	5.6	350	3.000K	1.270	>80
			4.000K	1.365	
LINEAR 10	15.9	350	3.000K	2.540	
			4.000K	2.730	

TEC.DRAWINGS

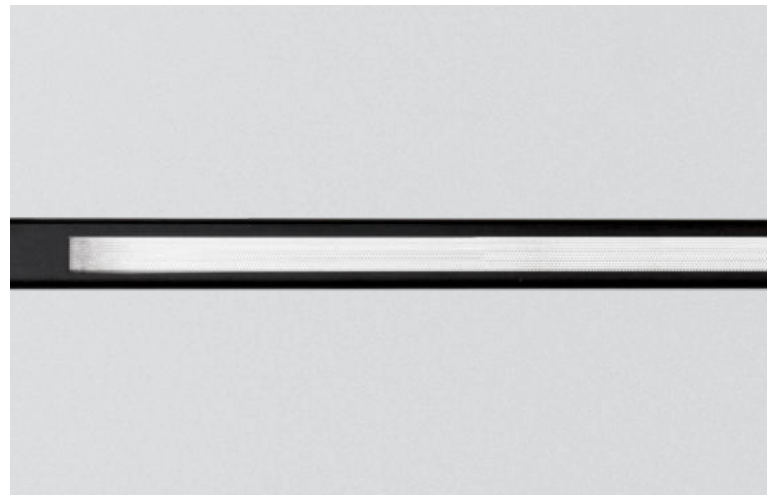
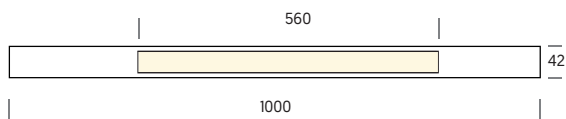
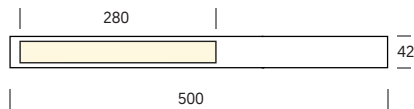

LED	230V	IP20	50.000h L90/B10	McAdam C3
500mm	≈ 5.6W	> 1.200lm	KLR5 A 05	• • • • • • • •
1.000mm	≈ 16W	> 2.500lm	KLR1 A 10	• • • • • • • •

BASIC OPTIONS

NO DIM	N	No Dimmable							
3K	3	3000K							
9	9	120°							
C	C	Microprismatic diff.							
WS	WS	Satin White	KLR5 A	05	N	3	9	C	WS
			KLR1 A	10	N	3	9	C	WS
BS	BS	Satin Black	KLR5 A	05	N	3	9	C	BS
			KLR1 A	10	N	3	9	C	BS

CUSTOMIZE OPTIONS

LED CONTROL									
DALI	D	Dimmable Dali	KLR• A	•	D	•	9	C	••
K	K	Casambi	KLR• A	•	K	•	9	C	••
D	D	Bluetooth	KLR• A	•	D	•	9	C	••
LED COLOR TEMPERATURE									
4K	4	4000K	KLR• A	•	•	4	9	C	••

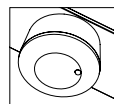

Para versión Bluetooth añadir Kit B.
For Version Bluetooth please add the Kit B.

Esto es un ejemplo gráfico de la funcionalidad de nuestro sistema. Es fácilmente adaptable a espacios multifuncionales, donde las luminarias hacen parte de dichos usos, hoy en día entendemos que los espacios son mutables y queremos que el Click sea esa iluminación polivalente que te acompañe.

This is a graphic example of the functionality of our system. It is easily adaptable to multifunctional spaces, nowadays we know that spaces are dynamic, and we want the Click System to be that polyvalent lighting that accompanies you.





BALO
NEW
CLICK
ARRIVAL
UP
PENDANT

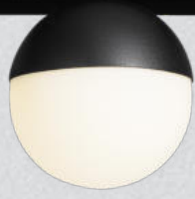

BALO

LINEAR SYSTEMS

El Balo es una luminaria esférica, que cuenta con una mitad opaca que permite ocultar el punto de luz y mejora el confort visual, además cuenta con versiones: en suspensión y otra de superficie en el perfil.

Balo is a spherical luminaire, it has an opaque half that allow you to hide the point of Light and improves the visual comfort, it even has two versions: a pendant one and other Surface in the profile.

CLICK BALO

LINEAR SYSTEMS



	W	mA	TEMP	LUM	CRI
BALO PENDANT	8.2	500	2.700K	2x505	>80
			3.000K	2x536	
BALO UP			2.700K	2x505	
			3.000K	2x536	



TEC.DRAWINGS

BALO PENDANT

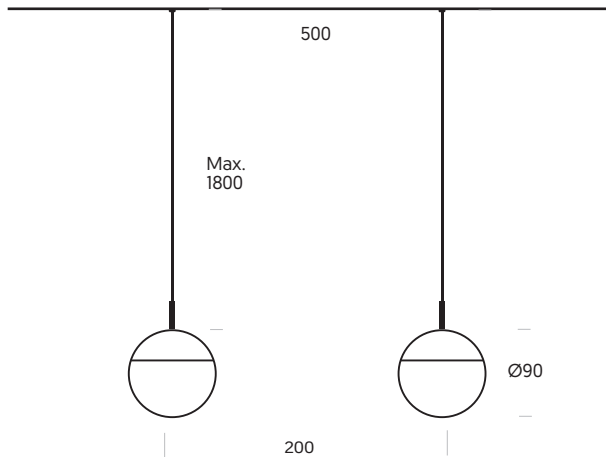

BALO UP

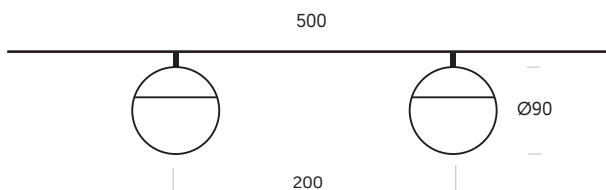

LED 230V IP20

Balo PENDANT ≈ 8W >2x500lm **KBLP A 04 . . 9 A ..**
 Balo UP ≈ 8W >2x500lm **KBLU A 04 . . 9 A ..**

BASIC OPTIONS

NO DIM	N No Dimmable								
3K	3 3000K								
9	9 120°								
A	A Ice Difusser								
WB	WB White Black	KBL	A	04	N	3	9	A	WB
BS	BS Satin Black	KBL	A	04	N	3	9	A	BS

CUSTOMIZE OPTIONS

LED CONTROL

DALI	D Dimmable Dali	KBL	A	04	D	.	9	A	..
K	K Casambi	KBL	A	04	K	.	9	A	..
D	D Bluetooth	KBL	A	04	D	.	9	A	..

LED COLOR TEMPERATURE

2.7K	2 2700K	KBL	A	04	.	2	9	A	..
-------------	----------------	-----	---	----	---	----------	----------	----------	-----------

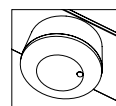

Para versión Bluetooth añadir Kit B.
 For Version Bluetooth please add the Kit B.

Click Balo

Balo Surface - Balo Pendant



Luz de ambiente / General light

El Balo es una luminaria que genera una luz ambiental homogénea, ideal para esos espacios a los que quieres dar esa sensación de confort y calidez.

Balo is a luminaire that generates a homogeneous ambient light, this is ideal for the space that you want to give the feeling of comfort and warmth.



Luz de acento fija / Fixed accent light

EL Mont es una luz de acento fijo, que como el Tube nos ayuda a destacar esos pequeños detalles que pasan desapercibidos.

Mont is a fixed light like the Tube luminaire, it helps to distinguish the unnoticed little details.

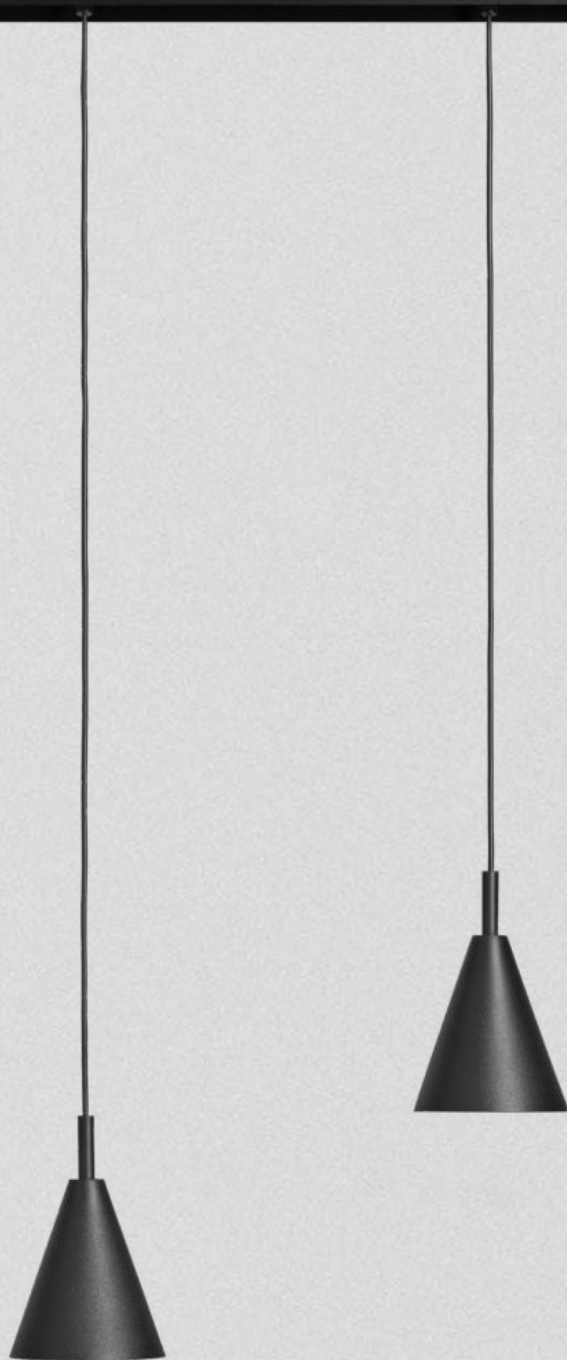

MONT

LINEAR SYSTEMS

Mont está fabricado con un cuerpo de aluminio, acompañado de un difusor opal en relieve que ayuda a mejorar el nivel UGR, por otra parte, cuenta con una boca rehundida que mejora el confort visual y le da ese toque de tecnicidad a esta luminaria.

Mont is an aluminum luminaire, it has an opal diffuser that helps to improve the UGR level, by otherwise it has a recessed reflector that gives comfort visual and technical image.

CLICK MONT

LINEAR SYSTEMS



	W	mA	TEMP	LUM	CRI
MONT	10	300	3.000K	2x755	>80

TEC.DRAWINGS

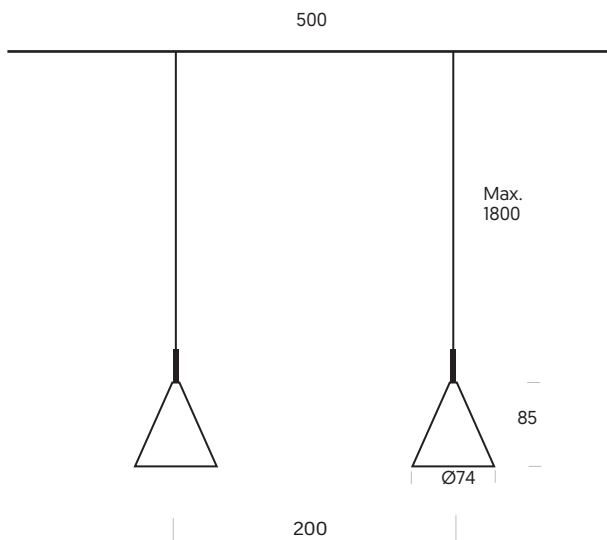

DETAIL PHOTO



Détail intérieur du Mont
Dettagli interni del Mont



LED 230V IP20

Mont Click ≈10W >2x750lm **KMT2 A 05 • • 3 A ••**

BASIC OPTIONS

NO DIM	N	No Dimmable								
3K	3	3000K								
35°	3	35°								
A	A	Ice Difusser								
BS	BS	Satin Black	KMT2	A	05	N	3	3	A	BS
WB	WB	White Black	KMT2	A	05	N	3	3	A	WB

CUSTOMIZE OPTIONS

LED CONTROL										
DALI	D	Dimmable Dali	KMT2	A	05	D	•	3	A	••
K	K	Casambi	KMT2	A	05	K	•	3	A	••
D	D	Bluetooth	KMT2	A	05	D	•	3	A	••

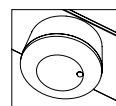

Para versión Bluetooth añadir Kit B.
For Version Bluetooth please add the Kit B.

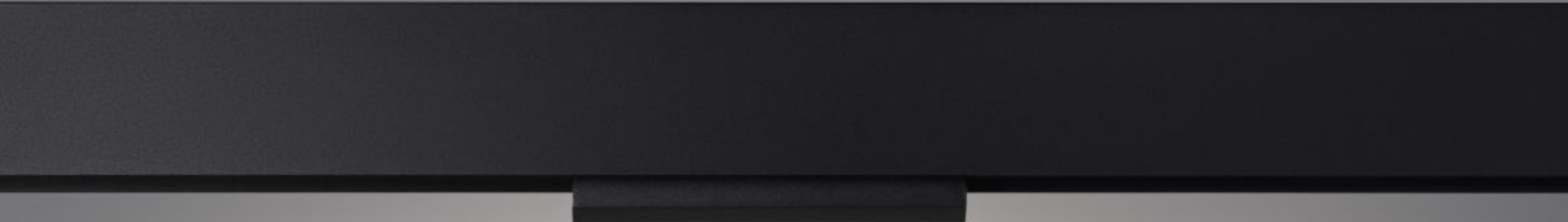

WALLWASHER
LINEAR SYSTEMS

CLICK WALLWASHER

LINEAR SYSTEMS



	W	mA	TEMP	LUM	CRI
WALLWASHER	10	700	3.000K	1.100	>90

TEC.DRAWINGS

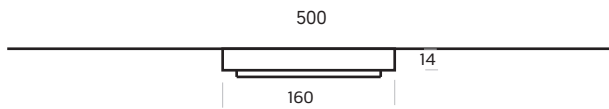

SIDE VIEW

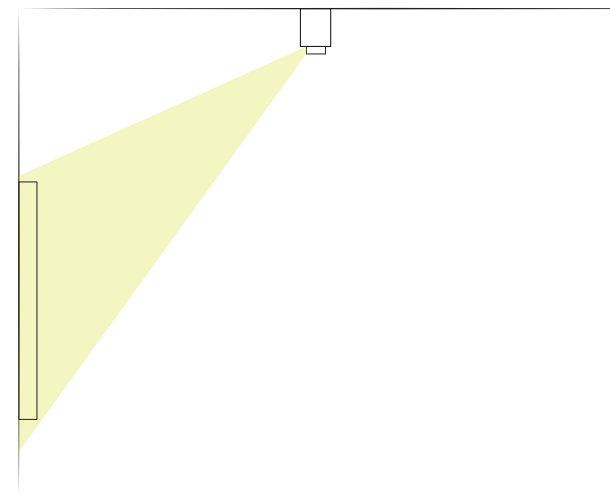

Wallwasher ≈ 10W >1.100lm **KWAL A 10 . . 9 A ..**

BASIC OPTIONS

	N	No Dimmable	
	3	3000K	
	9	Wallwasher	
	A	Ice Difusser	
	BS	Satin Black	KWAL A 10 N 3 9 A BS

CUSTOMIZE OPTIONS

LED CONTROL

	D	Dimmable Dali	KWAL A 10 D 3 9 A BS
	K	Casambi	KWAL A 10 K 3 9 A BS
	D	Bluetooth	KWAL A 10 D 3 9 A BS

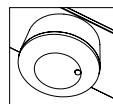

Para versión Bluetooth añadir Kit B.
For Version Bluetooth please add the Kit B.

NEW CLICK BLUETOOTH

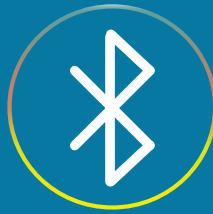

Hemos incorporado 2 nuevas opciones de regulación Bluetooth para nuestro Click System, a continuación veras una comparativa con las principales características
 We have added 2 new options Bluetooth control for our Click System, below you will see a comparative with the main characteristics



CASAMBI



BLUETOOTH

No DALI wiring	<input checked="" type="checkbox"/>	<input checked="" type="checkbox"/>
No switchboards	<input checked="" type="checkbox"/>	<input checked="" type="checkbox"/>
APP	Casambi	LiNA touch
Bluetooth	Added to each luminaire	Added only on Kit Bluetooth
Scope	25-30m	25-30m

ACCESORIES

Wireless Switch	<input checked="" type="checkbox"/>	<input checked="" type="checkbox"/>
Light Sensor	<input checked="" type="checkbox"/>	<input checked="" type="checkbox"/>
Motion Sensor	<input checked="" type="checkbox"/>	<input checked="" type="checkbox"/>

APP

	Casambi user	LiNA Connect configurator	LiNA Connect user
On/Off	<input checked="" type="checkbox"/>		<input checked="" type="checkbox"/>
Brightness Control	<input checked="" type="checkbox"/>		<input checked="" type="checkbox"/>
Temperature Color	<input checked="" type="checkbox"/>		<input checked="" type="checkbox"/>
Gruouping	<input checked="" type="checkbox"/>		<input checked="" type="checkbox"/>
Scenes	<input checked="" type="checkbox"/>	<input checked="" type="checkbox"/>	
Sunrise & Sunset	<input checked="" type="checkbox"/>	<input checked="" type="checkbox"/>	
Calendar & Timer	<input checked="" type="checkbox"/>	<input checked="" type="checkbox"/>	
Accessories setting up	<input checked="" type="checkbox"/>	<input checked="" type="checkbox"/>	

CLICK CASAMBI

LINEAR SYSTEMS



Ahora el sistema Click cuenta con su versión Casambi en todas las luminarias.

Now Click System is available on Casambi version for all fixtures.

MODULES WITH CASAMBI



C. Focus 25



C. Focus 40



C. Focus 55



C. Tube 25



C. Dot 5

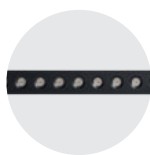

C. Dot 10



C. Linear



C. Wallwasher



C. Mont



C. Balo Pendant



C. Balo Up

APP

CASAMBI



Aplicación compatible con todos los sistemas Android 4.4 [KitKat] y posteriores, iPhone 4S [iOS 5.0] y posteriores y iPad 3 [iOS 5.1] y posteriores.

App compatible with all systems: Android 4.4 [KitKat] or later, iPhone 4S [iOS 5.0] or later and iPad 3 [iOS 5.1] and or later.

ALCANCE / SCOPE

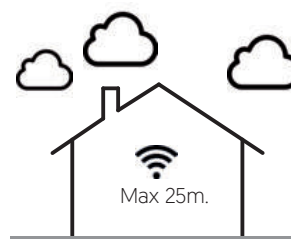

El rango de este dispositivo depende en gran medida de los elementos que lo rodeen y de los obstáculos, tales como muros y paredes.

The range of this device depends largely on the surrounding elements and obstacles, such as walls.

ACCESORIOS / ACCESSORIES

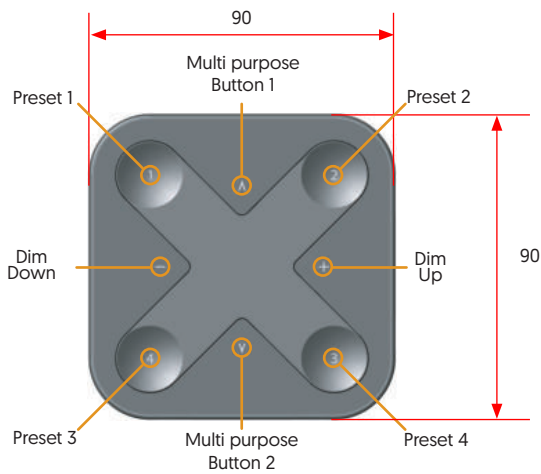

Interruptor de pared inalámbrico con batería, compatible con aplicación Casambi

Wireless wall switch with battery, compatible with Casambi app.

XPRESS

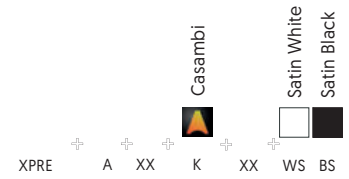

LIGHT & MOVEMENT SENSOR

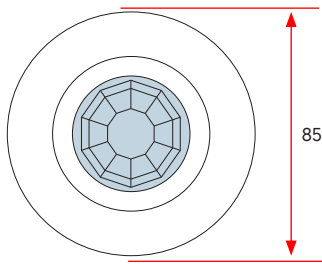

Sensor de movimiento y luz compatible con aplicación Casambi, dos tipos de instalaciones superficie y empotrable.

Motion and light sensor compatible with Casambi application, two types of surface and recessed installations.

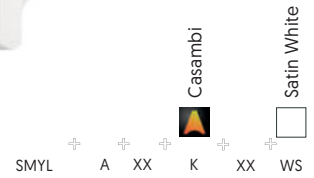

AREA DE RECONOCIMIENTO LUMINICO LIGHT LEVEL RECOGNITION AREA

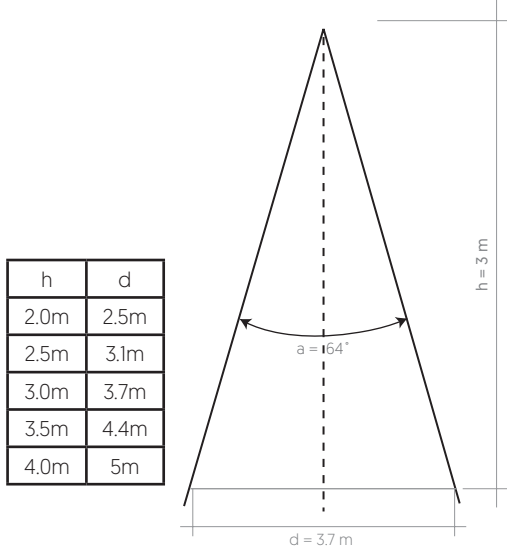

DETECTOR DE PRESENCIA PRESENCE / MOTION DETECTION

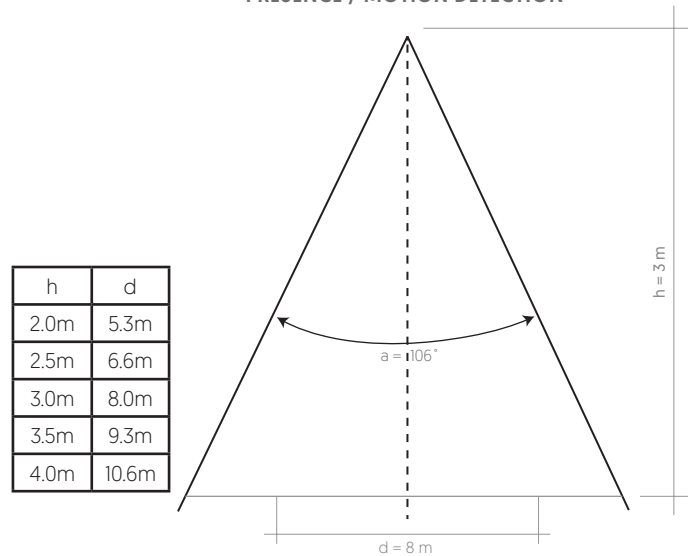



CONTROL



Smartwatch



Smartphone

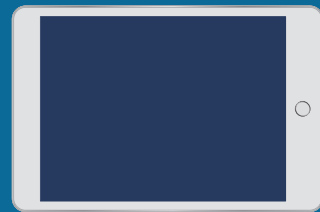

Tablet

ACCESORIES

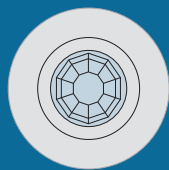

Lighting Sensor

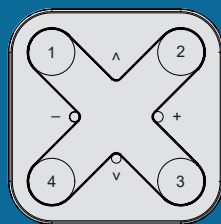

Xpress

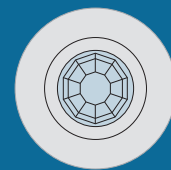

Motion Sensor

CLICK KIT BLUETOOTH

LINEAR SYSTEMS



El Kit bluetooth es un accesorio modular para la familia CLICK SYSTEM. El kit incluye el sensor y alimentador. Su función es el control y gestión inalámbrico a través de protocolo Bluetooth que permite controlar cada una de las luminarias que se incorporen en el sistema Click.

The Bluetooth Kit is a modular accessory for the CLICK SYSTEM family. The kit includes the sensor and feeder. Its function is wireless control and management through Bluetooth protocol that allows controlling each of the fixtures that are incorporated in the Click system.

TEC.DRAWINGS

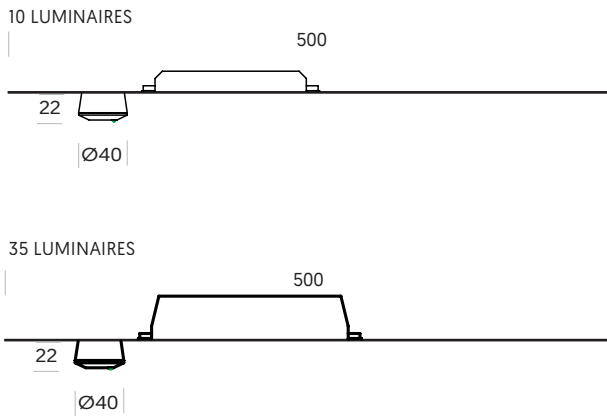

Disponible pronto / Available soon.

APP



LiNA Touch

Aplicación compatible con sistema iOS 10 o superior, y Andorid 5 o superior.
Compatible with Android 5 or later and iOS 10 or Later.



Disponible pronto
Coming soon.



Disponible
Available.

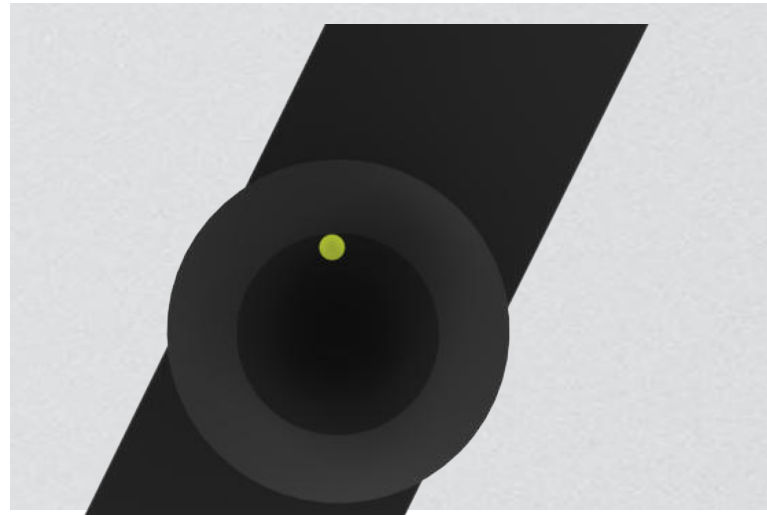

Kit BLUETOOTH

KBL2 A .. X X X X ..

CUSTOMIZE OPTIONS

LUMINAIRES

10	10	Max. 10 Luminaires	KBL2	A	10	X	X	X	X	..
35	35	Max. 35 Luminaires	KBL2	A	35	X	X	X	X	..

COLOURS

	WS	Satin White	KBL2	A	..	X	X	X	X	WS
	BS	Satin Black	KBL2	A	..	X	X	X	X	BS

ALCANCE / SCOPE

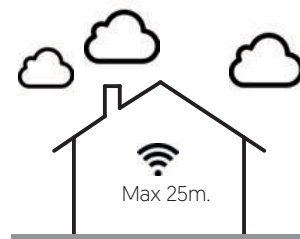

El rango de este dispositivo depende en gran medida de los elementos que lo rodeen y de los obstáculos, tales como muros y paredes.

The range of this device depends largely on the surrounding elements and obstacles, such as walls.

3 SENCILLOS PASOS / ONLY 3 EASY STEPS

Descargar la App gratuita
Download the free App.



LiNA Touch

1

Escanea tu QR personalizado
Scan your customized QR.



QR

2

A jugar con la luz
Play with light



3

FACIL CONFIGURACIÓN / EASY SET UP

Configurar el kit bluetooth no podría ser más sencillo, solo identificas tu QR personalizado y listos para jugar.
Setting up the bluetooth kit is very easy, only scan your customized QR and ready to play.

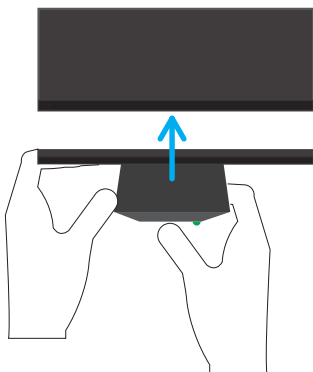

Conecta el Kit Bluetooth a tu Click system
Connect the Bluetooth Kit to your Click system.

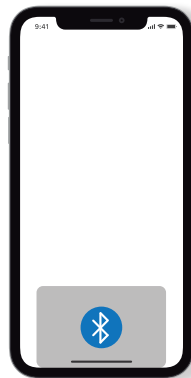

Habilita el bluetooth en tu móvil
Turn on the bluetooth on your mobile.

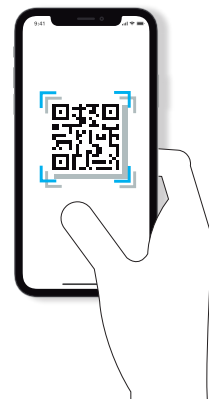

Abre la app LiNA Touch y escanea tu QR
Open the LiNA Touch APP then scan your QR.

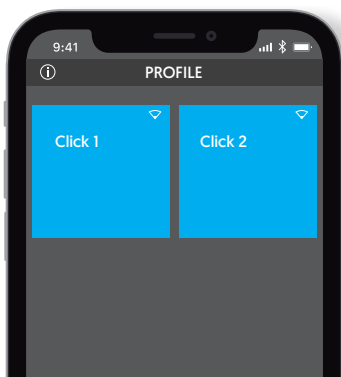

Selecciona el sistema a regular
Choose the system you want to dim.

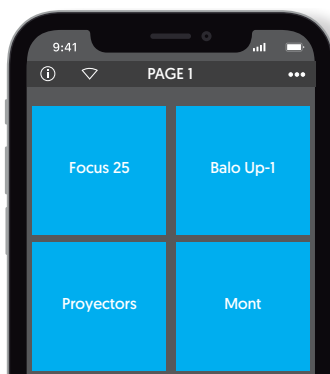

Elige la luminaria o grupo a regular
Choose fixture or scene to dim.

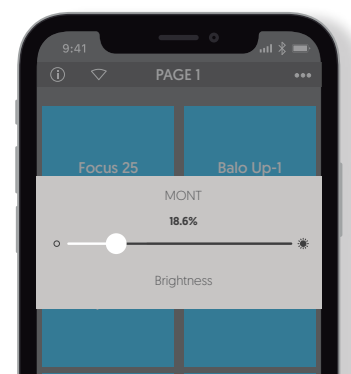

Regula la luminaria o grupo elegido
Dim the choosen fixture or scene